

- ▶ **Moldes estándar**  
Moldes texturizados para paneles de hormigón  
Moldes aplicados para fachadas  
Moldes prefabricados para suelos  
Moldes balaustradas, columnas, varas  
Moldes para impresión de hormigón  
Vigas de hormigón imitación madera  
Brazales y coronamiento de piscinas  
Mobiliario urbano
- ▶ **Rehabilitaciones e impermeabilizaciones**
- ▶ **Proyectos e sistemas especiales**
- ▶ **Herramientas**
- ▶ **Aditivos**

- ▶ **Moules standards**  
Moules texturisés pour panneaux de béton  
Moules pour pierres de façades  
Moules pré-fabriqués pour sols  
Moules pour balustrades, colonnes, autres  
Moules pour empreinte de béton  
Poutres de béton (imitation bois)  
Margelles et couronnement de piscines  
Mobilier urbain
- ▶ **Rehabilitation et imperméabilisation**
- ▶ **Projet et systèmes spéciaux**
- ▶ **Outils**
- ▶ **Additifs**

- ▶ **Standard moulds**  
Structured moulds for cement's panels  
Moulds for façade's stones  
Moulds to make prefabricated for surfaces  
Moulds for balustrades, columns, others  
Moulds for cement's imprint  
Cement's beams (wooden imitation)  
Curbs and swimming pool's crowing  
Street furniture and fixtures
- ▶ **Restoration and proofing**
- ▶ **Special project and systems**
- ▶ **Tools**
- ▶ **Additives**



**Moldes estándar**  
para prefabricados de hormigón

**Moules standard**  
pour éléments préfabriqués en béton

**Standard Moulds**  
for precast concrete products

**Moldes estándar** para prefabricados de hormigón  
**Moules standard** pour éléments préfabriqués en béton  
**Standard Moulds** for precast concrete products

▶ **Baldosas y aplacados**

Moldes fabricados en elastómero de poliuretano para la producción de baldosas y aplacados de fachada con gran diversidad de relieves y texturas.

Les ofrecemos los productos y técnicas para el envejecido del material una vez fabricado.

▶ **Dalles et revêtements en pierre**

Moules fabriqués en élastomère de polyuréthane pour la production de dalles et de pierres de façade avec un grand choix de reliefs et de textures.

Nous vous proposons les produits et les techniques nécessaires pour obtenir le vieillissement du matériau une fois fabriqué.

▶ **Paving and cladding**

Moulds made out of polyurethane elastomer for the production of paving and cladding for façades with a great variety of surface designs and textures.

We also offer products and techniques for aging the material once manufactured.

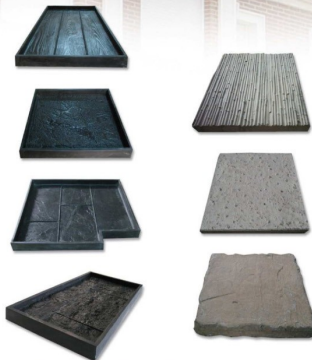

Molde poliéster con refuerzo metálico  
Moule polyester avec renfort métallique  
Polyester mould with metallic reinforcement



▶ **Moldes estándar**

Moldes fabricados en termoplástico, poliéster reforzado con fibra de vidrio, metal, poliuretano o silicona. Columnas, balaustradas, pilares, remates pilar, pasamanos y toda una gama de piezas de pequeño y medio tamaño, para una interesante gama de productos, que seguro completará su producción.

▶ **Moules standard**

Moules fabriqués en thermoplastique, polyester renforcé de fibre de verre, métal, polyuréthane ou silicone. Colonnes, balustrades, piliers, finitions de pilier, mains courantes et toute une gamme de pièces de petite et moyenne taille, pour une gamme de produits intéressante qui complètera sans doute votre production.

▶ **Standard moulds**

Moulds manufactured in thermoplastic, fibreglass-reinforced polyester, metal, polyurethane or silicon. Columns, balustrades, pillars, pillar heads, hand-rails and a whole range of small and medium-sized pieces, for an interesting range of products which will surely complete your production needs.



Molde plástico  
Moule plastique  
Plastic mould



Molde metálico  
Moule métallique  
Metallic mould



Molde poliéster  
Moule polyester  
Polyester mould

BALUSTRES PLASTICOS  
PLASTIC BALUSTER  
BALAUSTRE PLASTIQUE

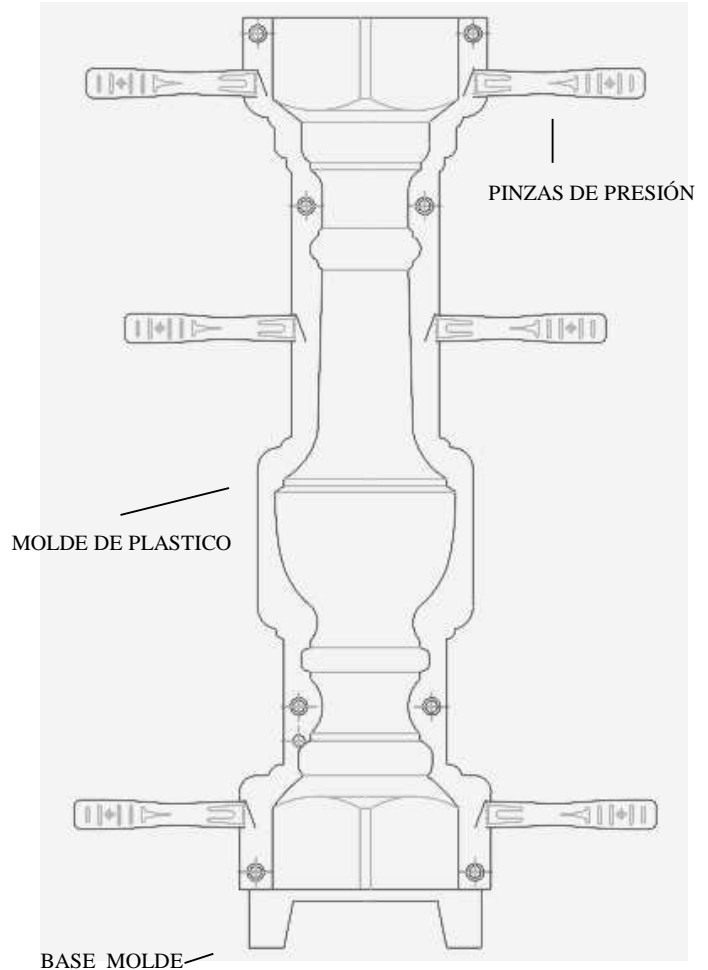

MOLDES BALUSTRE EN INYECCIÓN DE TERMOPLASTICO  
( ABS )

OFRECE UNA GRAN RESISTENCIA EN EL MOLDEADO DE  
HORMIGON.

SISTEMA DE CIERRE RAPIDO.

OTRAS MEDIDAS A CONSULTAR Tel(34)93 634 00 81

ASK FOR DIFFERENTS SIZES

CONSULTER AUTRES MESURES

1

**BALUSTRES PLASTICOS**  
**PLASTIC BALUSTER**  
**BALAUSTRÉ PLASTIQUE**

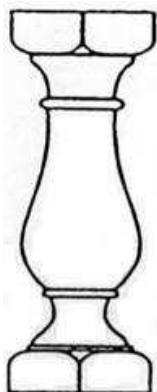

REFERENCIA	DESCRIPCIÓN	MEDIDAS CM
B.0701	PL-BALUSTRE	35X10X10

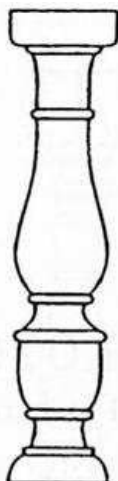

REFERENCIA	DESCRIPCIÓN	MEDIDAS CM
B.0702	PL-BALUSTRE	46X8

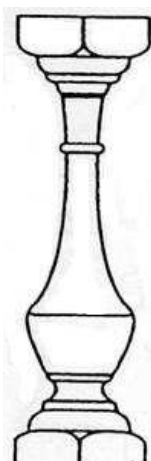

REFERENCIA	DESCRIPCIÓN	MEDIDAS CM
B.0703	PL-BALUSTRE	50X12X12

OTRAS MEDIDAS A CONSULTAR Tel(34)93 634 00 81

2

ASK FOR DIFFERENTS SIZES

CONSULTER AUTRES MESURES

**BALUSTRES PLASTICOS**  
**PLASTIC BALUSTER**  
**BALAUSTRÉ PLASTIQUE**

---

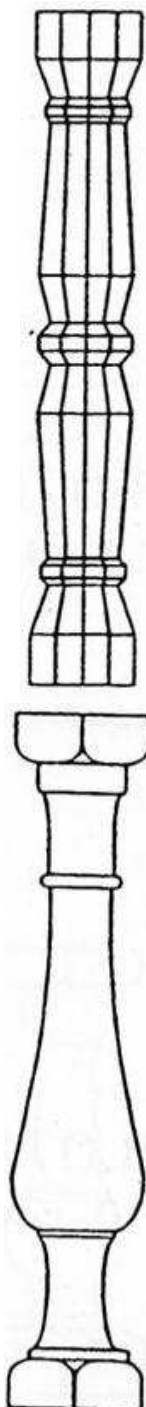

REFERENCIA	DESCRIPCIÓN	MEDIDAS CM
------------	-------------	------------

B.0704	PL-BALUSTRE	69X10X10
--------	-------------	----------

REFERENCIA	DESCRIPCIÓN	MEDIDAS CM
------------	-------------	------------

B.0705	PL-BALUSTRE	69X10X10
--------	-------------	----------

---

OTRAS MEDIDAS A CONSULTAR Tel(34)93 634 00 81

ASK FOR DIFFERENTS SIZES

CONSULTER AUTRES MESURES

3

**BALUSTRES PLASTICOS**  
**PLASTIC BALUSTER**  
**BALAUSTRÉ PLASTIQUE**

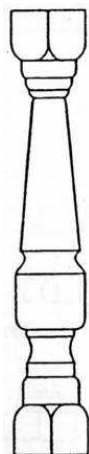

REFERENCIA	DESCRIPCIÓN	MEDIDAS CM
------------	-------------	------------

B.0706	PL-BALUSTRE	75X10X10
--------	-------------	----------

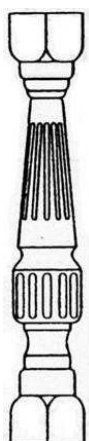

REFERENCIA	DESCRIPCIÓN	MEDIDAS CM
------------	-------------	------------

B.0707	PL-BALUSTRE	75X10X10
--------	-------------	----------



REFERENCIA	DESCRIPCIÓN	MEDIDAS CM
------------	-------------	------------

B.0708	PL-BALUSTRE	75X12X12
--------	-------------	----------

OTRAS MEDIDAS A CONSULTAR Tel(34)93 634 00 81

4

ASK FOR DIFFERENTS SIZES

CONSULTER AUTRES MESURES

**BALUSTRES PLASTICOS**

**PLASTIC BALUSTER**

**BALAUSTRÉ PLASTIQUE**

---

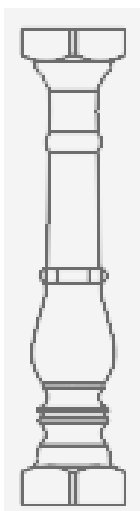

REFERENCIA	DESCRIPCIÓN	MEDIDAS CM
------------	-------------	------------

B.0723	PL-BALUSTRE	73,5X12X12
--------	-------------	------------

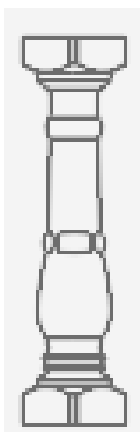

REFERENCIA	DESCRIPCIÓN	MEDIDAS CM
------------	-------------	------------

B.0724	PL-BALUSTRE	50X10X10
--------	-------------	----------

---

OTRAS MEDIDAS A CONSULTAR Tel(34)93 634 00 81

8

ASK FOR DIFFERENTS SIZES

CONSULTER AUTRES MESURES

**BALUSTRES PLASTICOS**  
**PLASTIC BALUSTER**  
**BALAUSTRÉ PLASTIQUE**



REFERENCIA	DESCRIPCIÓN	MEDIDAS CM
B.0725	PL-BALUSTRE	70X12,5X12,5



REFERENCIA	DESCRIPCIÓN	MEDIDAS CM
B.0726	PL-BALUSTRE	85 x 9,8 x 9,8



REFERENCIA	DESCRIPCIÓN	MEDIDAS CM
B.0727	PL-BALUSTRE	85X9,8X9,8

OTRAS MEDIDAS A CONSULTAR Tel(34)93 634 00 81

9

ASK FOR DIFFERENTS SIZES

CONSULTER AUTRES MESURES

**BALUSTRES FIBRA**  
**FIBER BALUSTER**  
**BALAUSTRÉ FIBRE**

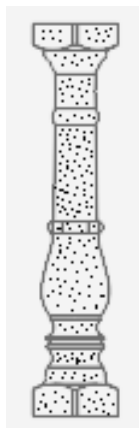

REFERENCIA	DESCRIPCIÓN	MEDIDAS CM
B.0732	P-BALUSTRE	74X12X12

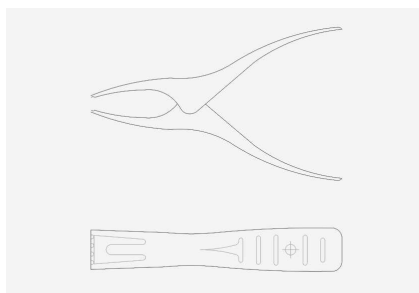

REFERENCIA	DESCRIPCIÓN	MEDIDAS CM
PIN.01	MT-PINZAS	82X9X9,5

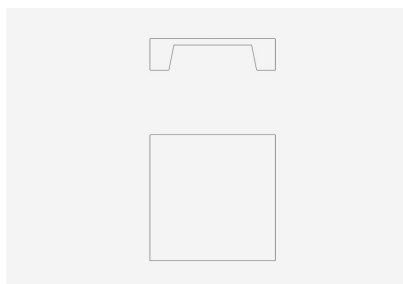

REFERENCIA	DESCRIPCIÓN	MEDIDAS CM
BS.01	MT-BASE BALUSTRE	20X20X5

OTRAS MEDIDAS A CONSULTAR Tel(34)93 634 00 81

ASK FOR DIFFERENTS SIZES

CONSULTER AUTRES MESURES

**BALUSTRES FIBRA**  
**FIBER BALUSTER**  
**BALAUSTRÉ FIBRE**

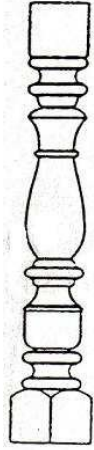

REFERENCIA	DESCRIPCIÓN	MEDIDAS CM
B.0012	P-BALUSTRE	82X11X11,5

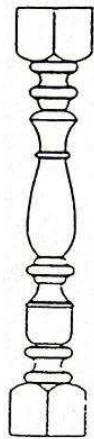

REFERENCIA	DESCRIPCIÓN	MEDIDAS CM
B.0013	P-BALUSTRE	82X9X9,5

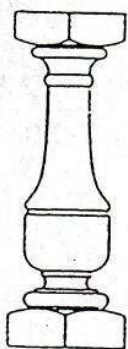

REFERENCIA	DESCRIPCIÓN	MEDIDAS CM
B.0014	P-BALUSTRE	60X14X15

OTRAS MEDIDAS A CONSULTAR Tel(34)93 634 00 81

ASK FOR DIFFERENTS SIZES

CONSULTER AUTRES MESURES

**BALUSTRES FIBRA**  
**FIBER BALUSTER**  
**BALAUSTRÉ FIBRE**

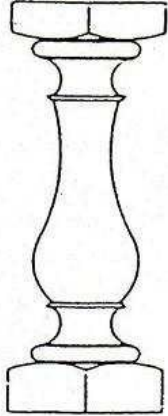

REFERENCIA	DESCRIPCIÓN	MEDIDAS CM
B.0015	P-BALUSTRE	61X18X19

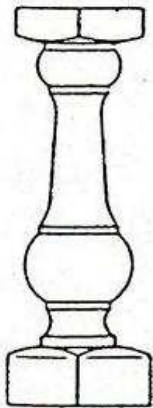

REFERENCIA	DESCRIPCIÓN	MEDIDAS CM
B.0016	P-BALUSTRE	56,5X13X14,5

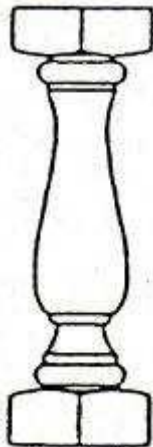

REFERENCIA	DESCRIPCIÓN	MEDIDAS CM
B.0017	P-BALUSTRE	43,5X10,5X10,65

OTRAS MEDIDAS A CONSULTAR Tel(34)93 634 00 81

ASK FOR DIFFERENTS SIZES

CONSULTER AUTRES MESURES

**BALUSTRES FIBRA**  
**FIBER BALUSTER**  
**BALAUSTRÉ FIBRE**

---

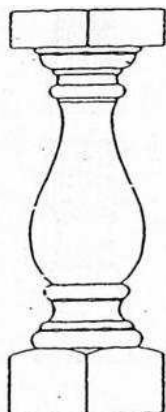

REFERENCIA	DESCRIPCIÓN	MEDIDAS CM
------------	-------------	------------

B.0018	P-BALUSTRE	57X16X16
--------	------------	----------

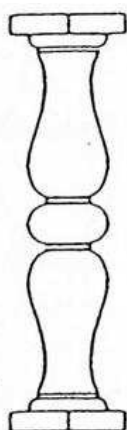

REFERENCIA	DESCRIPCIÓN	MEDIDAS CM
------------	-------------	------------

B.0019	P-BALUSTRE	61X13X13
--------	------------	----------



REFERENCIA	DESCRIPCIÓN	MEDIDAS CM
------------	-------------	------------

B.0020	P-BALUSTRE	61X12,5X12,5
--------	------------	--------------

---

OTRAS MEDIDAS A CONSULTAR Tel(34)93 634 00 81

ASK FOR DIFFERENTS SIZES

CONSULTER AUTRES MESURES

**BALUSTRES FIBRA**  
**FIBER BALUSTER**  
**BALAUSTRÉ FIBRE**

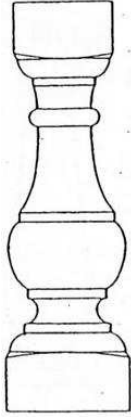

REFERENCIA	DESCRIPCIÓN	MEDIDAS CM
B.0021	P-BALUSTRE	65,5X20X20

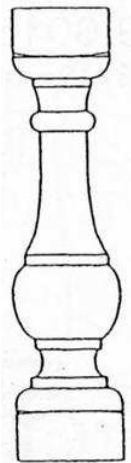

REFERENCIA	DESCRIPCIÓN	MEDIDAS CM
B.0022	P-BALUSTRE	65X16X16

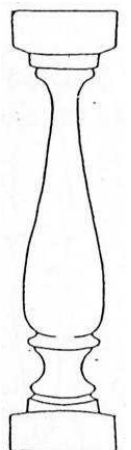

REFERENCIA	DESCRIPCIÓN	MEDIDAS CM
B.0023	P-BALUSTRE	81X20X20

OTRAS MEDIDAS A CONSULTAR Tel(34)93 634 00 81

ASK FOR DIFFERENTS SIZES

CONSULTER AUTRES MESURES

**BALUSTRES FIBRA**  
**FIBER BALUSTER**  
**BALAUSTRE FIBRE**

---

## MODO DE EMPLEO

Engrasado del molde con Decodesdesencofrante.

Montaje: Pinzas, base y varilla opcional de 6 –8 mm

Composición hormigón: 40% Cemento ( blanco o gris ).  
60% Arena ( ordinaria).  
Agua (mezcla hormigón liquido ).

Llenado: Aconsejamos utilizar tubo y embudo, introducir el útil en el molde  
Y verter el hormigón a través de este, alzándolo a medida que llenemos el  
molde, agitar con el mismo útil para eliminar el aire.

Secado y desmoldeo: 24 horas ( No exponer al sol ).

Barbotina: Cemento + agua. En caso de apreciar impurezas ( pequeños  
agujeros ) preparar barbotinay rellenar, eliminar barbotinasobrante con  
esponja húmeda.

---

OTRAS MEDIDAS A CONSULTAR Tel(34)93 634 00 81

ASK FOR DIFFERENTS SIZES

CONSULTER AUTRES MESURES

15

**PASAMANOS METALICOS**  
**METAL HANDRAIL**  
**MAIN-COURANTE MÉTALLIQUE**

---

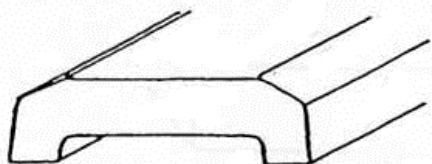

REFERENCIA	DESCRIPCIÓN	MEDIDAS CM
P.11	MT-PASAMANO	100X17X5

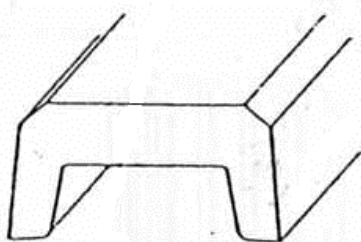

REFERENCIA	DESCRIPCIÓN	MEDIDAS CM
P.16	MT-PASAMANO	100X16X8

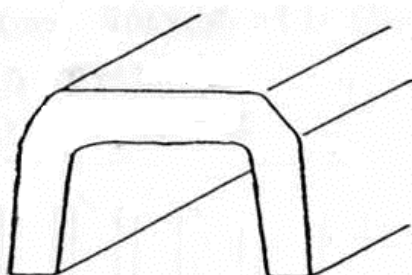

REFERENCIA	DESCRIPCIÓN	MEDIDAS CM
P18	MT-PASAMANO	100X17X9,5

---

OTRAS MEDIDAS A CONSULTAR Tel(34)93 634 00 81

16

ASK FOR DIFFERENTS SIZES

CONSULTER AUTRES MESURES

**PILARES POLIESTER**

**POLYESTER PIER**

**PILIER POLYESTER**

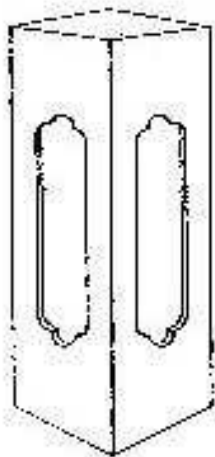

REFERENCIA	DESCRIPCIÓN	MEDIDAS CM
PL.02/3	P-PILAR	20X20X100
PL.02/4	P-PILAR	20X20X90
PL.02/5	P-PILAR	20X20X70
PL.02/6	P-PILAR	20X20X60

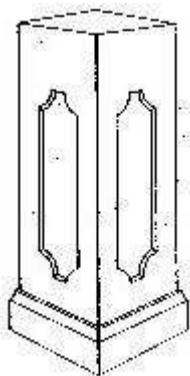

REFERENCIA	DESCRIPCIÓN	MEDIDAS CM
PL.03	P-PILAR	<b>20X20X105</b>

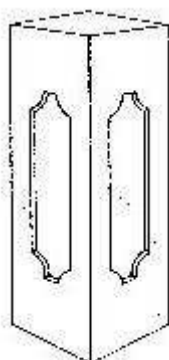

REFERENCIA	DESCRIPCIÓN	MEDIDAS CM
PL.05/1	P-PILAR	20X20X100
PL.05/2	P-PILAR	20X20X90
PL.05/3	P-PILAR	18X18X100
PL.05/4	P-PILAR	18X18X90
PL.06/5	P-PILAR	16X16X100

OTRAS MEDIDAS A CONSULTAR Tel(34)93 634 00 81

17

ASK FOR DIFFERENTS SIZES

CONSULTER AUTRES MESURES

**PILARES POLIESTER**

**POLYESTER PIER**

**PILIER POLYESTER**

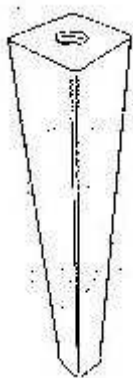

REFERENCIA	DESCRIPCIÓN	MEDIDAS CM
ACC/PL1	MT- CONTRAMOLDE	17X17X105

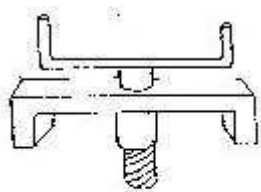

REFERENCIA	DESCRIPCIÓN	MEDIDAS CM
ACC/PL.2	EXTRACTOR CONTRAMOLDE	

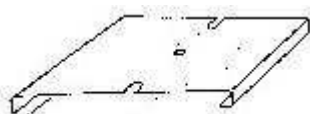

REFERENCIA	DESCRIPCIÓN	MEDIDAS CM
ACC/PL.3.1	P-BASE	30X30X3
ACC/PL.3.2	P-BASE	40X40X3

OTRAS MEDIDAS A CONSULTAR Tel(34)93 634 00 81

ASK FOR DIFFERENTS SIZES

CONSULTER AUTRES MESURES

## REJILLAS FIBRA

## FIBER GRATE

## GRILLE FIBRE

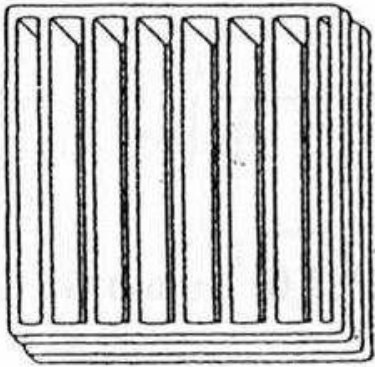

REFERENCIA	DESCRIPCIÓN	MEDIDAS CM
RJ.01	P-REJILLA	40X40
RJ.02	P-REJILLA	50X50
RJ.03	P-REJILLA	20X40

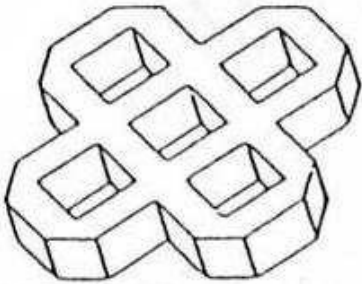

REFERENCIA	DESCRIPCIÓN	MEDIDAS CM
RJC.01	P-REJILLA CESPED	50X50X8

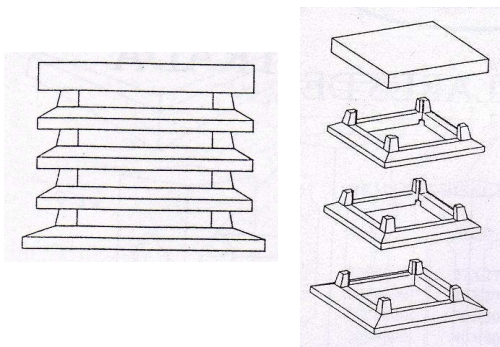

REFERENCIA	DESCRIPCIÓN	MEDIDAS CM
AE.01	C. ASPIRACIÓN ESTÁTICO	45X45
AE.02	C. ASPIRACIÓN ESTÁTICO	50X50
AE.03	C. ASPIRACIÓN ESTÁTICO	60X60
AE.04	PIEZA INTERMEDIA	

OTRAS MEDIDAS A CONSULTAR Tel(34)93 634 00 81

ASK FOR DIFFERENTS SIZES

CONSULTER AUTRES MESURES

**PASAMANOS POLIESTER**  
**POLYESTER HANDRAIL**  
**FINITION POUTRE POLYESTER**

---

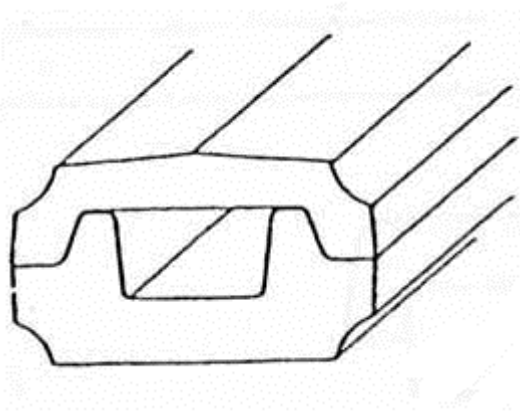

REFERENCIA	DESCRIPCIÓN	MEDIDAS CM
P.03	P-PASAMANOS	100X18X5
B.P.03	P-PASAMANOS	100X18X6,5

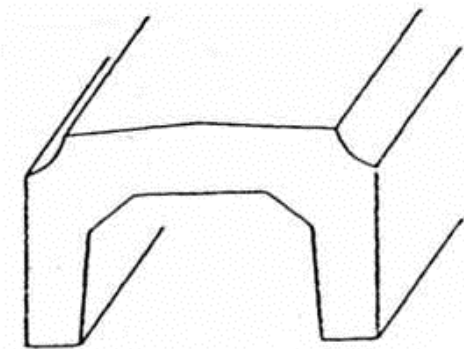

REFERENCIA	DESCRIPCIÓN	MEDIDAS CM
P.04	P-PASAMANOS	100X19X11,5

---

OTRAS MEDIDAS A CONSULTAR Tel(34)93 634 00 81

ASK FOR DIFFERENTS SIZES

CONSULTER AUTRES MESURES

## REMATES POLIESTER

## POLYESTER HEAD

## FINITION POUTRE POLYESTER

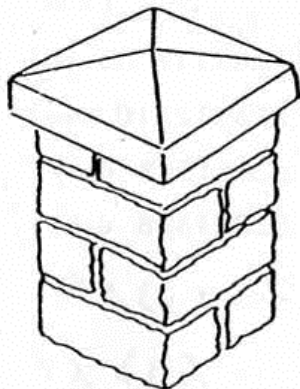

REFERENCIA	DESCRIPCIÓN	MEDIDAS CM
RM.01.2	P-REMATE	35X35X11
RM.01.4	P-REMATE	50X50X11

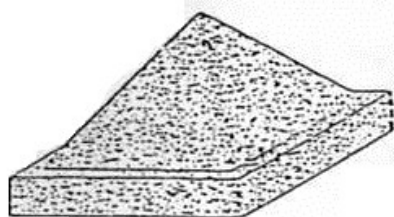

REFERENCIA	DESCRIPCIÓN	MEDIDAS CM
RPR.01.1	P-REMATE	28X28X21
RPR.01.2	P-REMATE	48X48X26
RPR.01.4	P-REMATE	23X23X18

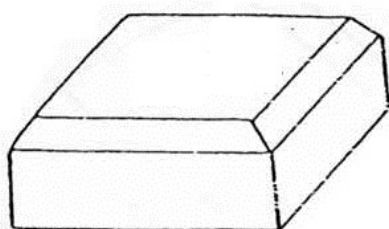

REFERENCIA	DESCRIPCIÓN	MEDIDAS CM
RBS.01.1	P-REMATE	27X27X5
RBS.01.2	P-REMATE	27X27X11
RBS.01.3	P-REMATE	30X30X6
RBS.01.4	P-REMATE	40X40X6
RBS.01.5	P-REMATE	45X30X6

OTRAS MEDIDAS A CONSULTAR Tel(34)93 634 00 81

ASK FOR DIFFERENTS SIZES

CONSULTER AUTRES MESURES

REMATES POLIESTER

POLYESTER HEAD

FINITION POUTRE POLYESTER

---



REFERENCIA	DESCRIPCIÓN	MEDIDAS CM
RB.01	P-REMATE BOLA	22X22X18D



REFERENCIA	DESCRIPCIÓN	MEDIDAS CM
RB.02	P-REMATE BOLA	20X25X25

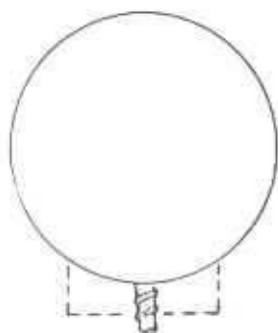

REFERENCIA	DESCRIPCIÓN	MEDIDAS CM
RB.03.1	P-REMATE BOLA	D.25
RB.03.2	P-REMATE BOLA	D.35

---

OTRAS MEDIDAS A CONSULTAR Tel(34)93 634 00 81

ASK FOR DIFFERENTS SIZES

CONSULTER AUTRES MESURES

REMATES POLIESTER

POLYESTER HEAD

FINITION POUTRE POLYESTER

---

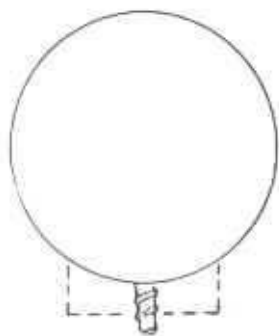

REFERENCIA	DESCRIPCIÓN	MEDIDAS CM
------------	-------------	------------

RB.04.02	P-REMATE BOLA CUELLO	D.35
----------	-------------------------	------



REFERENCIA	DESCRIPCIÓN	MEDIDAS CM
------------	-------------	------------

RB.05	P-REMATE BOLA COPA	22.5X22.5X35
-------	-----------------------	--------------



REFERENCIA	DESCRIPCIÓN	MEDIDAS CM
------------	-------------	------------

RB.06.1	P-REMATE PIÑA	19.5X19.5X28
---------	---------------	--------------

---

OTRAS MEDIDAS A CONSULTAR Tel(34)93 634 00 81

ASK FOR DIFFERENTS SIZES

CONSULTER AUTRES MESURES

REMATES POLIESTER

POLYESTER HEAD

FINITION POUTRE POLYESTER

---



REFERENCIA	DESCRIPCIÓN	MEDIDAS CM
------------	-------------	------------

ROCT.07	P-REMATE JARRON OCT.	25X25X35
---------	-------------------------	----------



REFERENCIA	DESCRIPCIÓN	MEDIDAS CM
------------	-------------	------------

RB.07	P-REMATE GRANADA	22X22X38
-------	---------------------	----------



REFERENCIA	DESCRIPCIÓN	MEDIDAS CM
------------	-------------	------------

ROB.01	P-REMATE OBE	22.5X22.5X40
--------	--------------	--------------

---

OTRAS MEDIDAS A CONSULTAR Tel(34)93 634 00 81

ASK FOR DIFFERENTS SIZES

CONSULTER AUTRES MESURES

**GARGOLAS POLIESTER**  
**POLYESTER GARGOYLE**  
**GALGOUILLE POLYESTER**

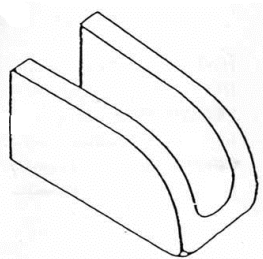

REFERENCIA	DESCRIPCIÓN	MEDIDAS CM
GR.02.1	P-GARGOLA	28X13X8 4UN.
GR.02.2	P-GARGOLA	28X13X8 6 UN

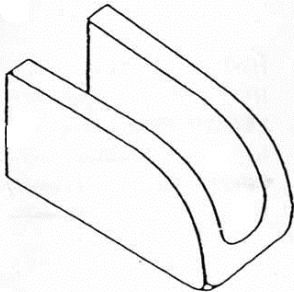

REFERENCIA	DESCRIPCIÓN	MEDIDAS CM
GR.03.1	P-GARGOLA	40X13X8 2UN.
GR.03.2	P-GARGOLA	40X13X8 4UN.

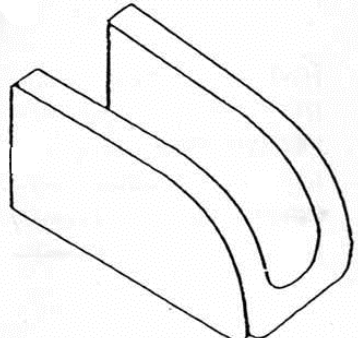

REFERENCIA	DESCRIPCIÓN	MEDIDAS CM
GR.04.1	P-GARGOLA	50X13X8 2UN.
GR.04.2	P-GARGOLA	50X13X8 4UN.

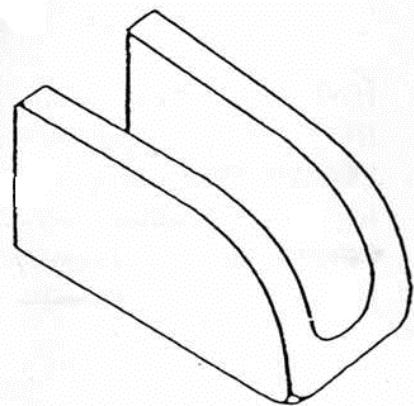

REFERENCIA	DESCRIPCIÓN	MEDIDAS CM
GR.05.1	P-GARGOLA	60X13X8 2UN.
GR.05.2	P-GARGOLA	60X13X8 4UN.

OTRAS MEDIDAS A CONSULTAR Tel(34)93 634 00 81

ASK FOR DIFFERENTS SIZES

CONSULTER AUTRES MESURES

**GARGOLAS POLIESTER**  
**POLYESTER GARGOYLE**  
**GALGOUILLE POLYESTER**

---

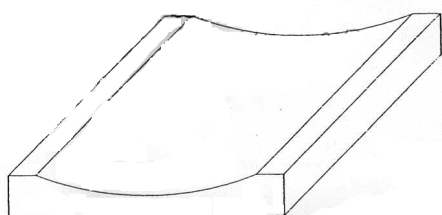

REFERENCIA	DESCRIPCIÓN	MEDIDAS CM
CNT.01	P-GARGOLAS	50X40X6

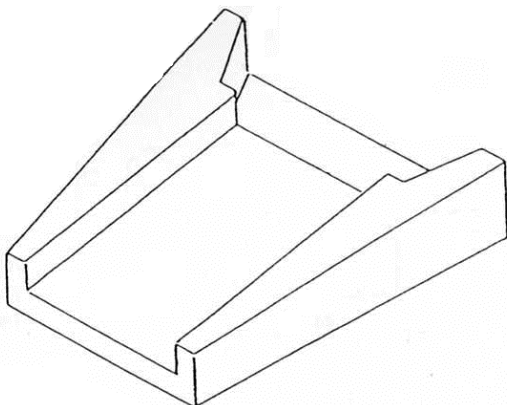

REFERENCIA	DESCRIPCIÓN	MEDIDAS CM
CNL.01	P-GARGOLAS	52X47X13

---

OTRAS MEDIDAS A CONSULTAR Tel(34)93 634 00 81

ASK FOR DIFFERENTS SIZES

CONSULTER AUTRES MESURES

**JARDINERAS POLIESTER**  
**POLYESTER FLOWERSTAND**  
**JARDINIÈRE POLYESTER**

---



REFERENCIA	DESCRIPCIÓN	MEDIDAS CM
JR.02	P-JARDINERA	D64X30



REFERENCIA	DESCRIPCIÓN	MEDIDAS CM
JR.09.1	P-JARDINERA	69X29X35
JR.09.2	P-JARDINERA	100X29X35

---

OTRAS MEDIDAS A CONSULTAR Tel(34)93 634 00 81

ASK FOR DIFFERENTS SIZES

CONSULTER AUTRES MESURES

**RECERCADO POLIESTER**  
**POLYESTER FRAME**  
**ENCADREMENT POLYESTER**

---

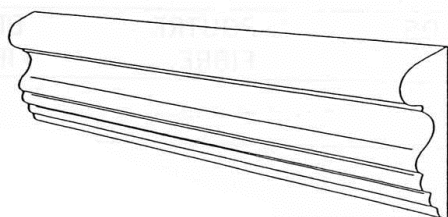

REFERENCIA	DESCRIPCIÓN	MEDIDAS CM
RC.01	P-RECERCADO	19X100

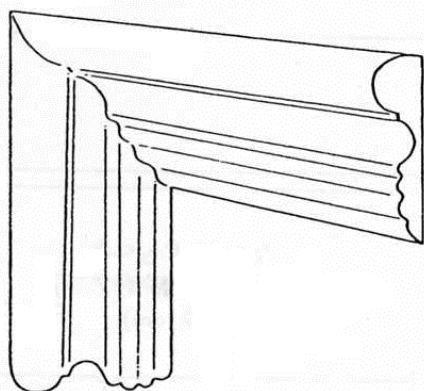

REFERENCIA	DESCRIPCIÓN	MEDIDAS CM
RC.02	P-RECERCADO	19,5X45X45,5

---

OTRAS MEDIDAS A CONSULTAR Tel(34)93 634 00 81

ASK FOR DIFFERENTS SIZES

CONSULTER AUTRES MESURES

**COLUMNA POLIESTER**  
**POLYESTER COLUMN**  
**COLONNE POLYESTER**

---

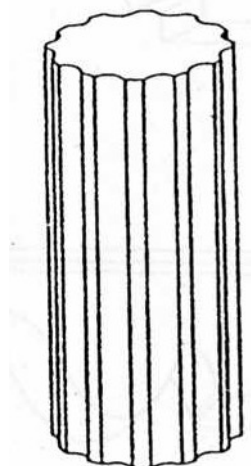

REFERENCIA	DESCRIPCIÓN	MEDIDAS CM
CL.01	P-COLUMNA	D21X50

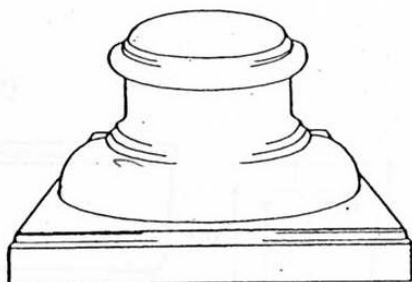

REFERENCIA	DESCRIPCIÓN	MEDIDAS CM
CP.01	P-CAPITEL	40X40X25

---

OTRAS MEDIDAS A CONSULTAR Tel(34)93 634 00 81

29

ASK FOR DIFFERENTS SIZES

CONSULTER AUTRES MESURES

**CANECILLOS POLIESTER**

**POLYESTER CORBEL**

**CORBEAUX POLYESTER**

---

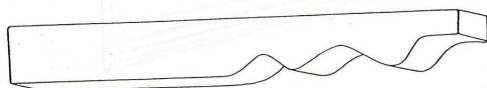

REFERENCIA	DESCRIPCIÓN	MEDIDAS CM
CN.01	P-CANECILLOS	25X25X35

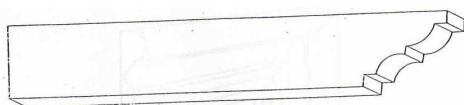

REFERENCIA	DESCRIPCIÓN	MEDIDAS CM
CN.02	P-CANECILLOS	22X22X38

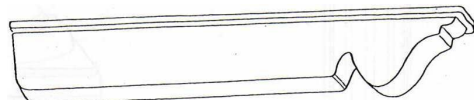

REFERENCIA	DESCRIPCIÓN	MEDIDAS CM
CN.04	P-CANECILLOS	22.5X22.5X40

---

OTRAS MEDIDAS A CONSULTAR Tel(34)93 634 00 81

30

ASK FOR DIFFERENTS SIZES

CONSULTER AUTRES MESURES

**BALDOSAS ELASTOMERO**  
**ELASTOMER TILE PAVING**  
**DALLES ÉLASTOMÈRE**

---

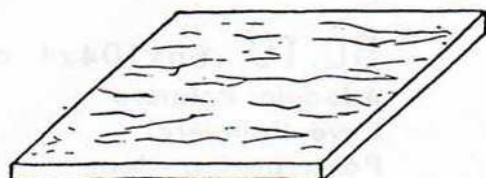

REFERENCIA	DESCRIPCIÓN	MEDIDAS CM
BL.01	E75-PIEDRA	50X50X4

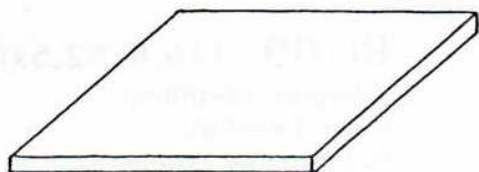

REFERENCIA	DESCRIPCIÓN	MEDIDAS CM
BL.02	E75-LISA	50X50X4

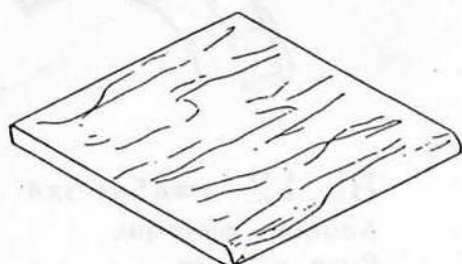

REFERENCIA	DESCRIPCIÓN	MEDIDAS CM
BL.03	E75-PIEDRA	50X50X4 R2,5

---

OTRAS MEDIDAS A CONSULTAR Tel(34)93 634 00 81

ASK FOR DIFFERENTS SIZES

CONSULTER AUTRES MESURES

**BALDOSAS ELASTOMERO**  
**ELASTOMER TILE PAVING**  
**DALLES ÉLASTOMÈRE**

---

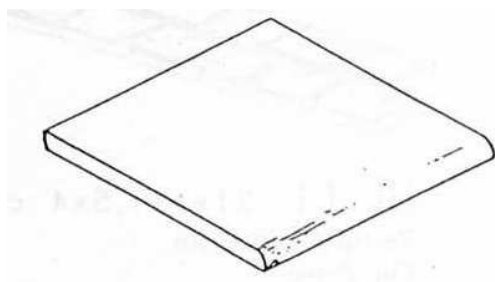

REFERENCIA	DESCRIPCIÓN	MEDIDAS CM
BL.04	E75-LISA	50X50X4 R2,5

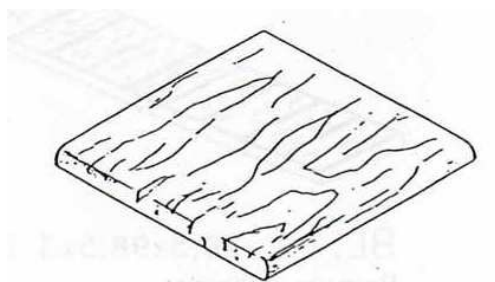

REFERENCIA	DESCRIPCIÓN	MEDIDAS CM
BL.05	E75-PIEDRA	50X50X4 2R2,5

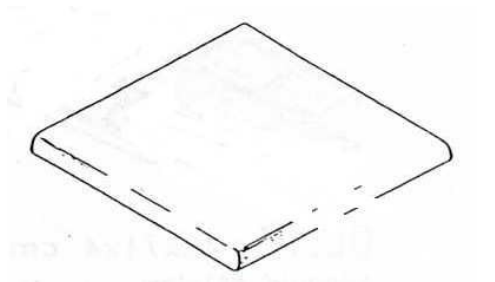

REFERENCIA	DESCRIPCIÓN	MEDIDAS CM
BL.06	E75-LISA	50X50X4 2R2,5

---

OTRAS MEDIDAS A CONSULTAR Tel(34)93 634 00 81

ASK FOR DIFFERENTS SIZES

CONSULTER AUTRES MESURES

**BALDOSAS ELASTOMERO**  
**ELASTOMER TILE PAVING**  
**DALLES ÉLASTOMÈRE**

---



REFERENCIA	DESCRIPCIÓN	MEDIDAS CM
BL.07	E75-MALLORQUINA	74X74X4

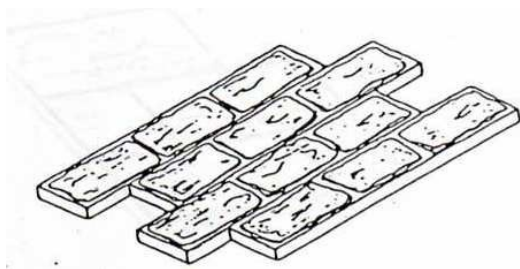

REFERENCIA	DESCRIPCIÓN	MEDIDAS CM
BL.08	E75-ADOQUIN RECTO	58X62X3,5



REFERENCIA	DESCRIPCIÓN	MEDIDAS CM
BL.09	E75-ADOQUIN ABANICO	116,5X52,5X4

---

OTRAS MEDIDAS A CONSULTAR Tel(34)93 634 00 81

ASK FOR DIFFERENTS SIZES

CONSULTER AUTRES MESURES

**BALDOSAS ELASTOMERO**  
**ELASTOMER TILE PAVING**  
**DALLES ÉLASTOMÈRE**

---

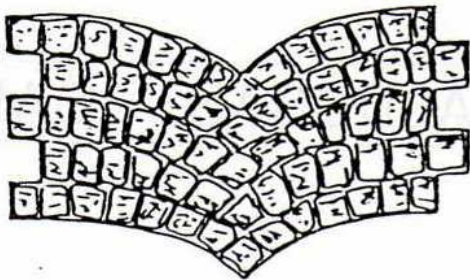

REFERENCIA	DESCRIPCIÓN	MEDIDAS CM
BL.10	E75-ADOQUIN PALMERA	66X104X4

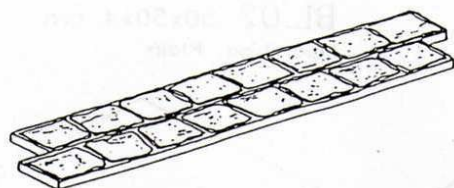

REFERENCIA	DESCRIPCIÓN	MEDIDAS CM
BL.11	E75-REMATE ADOQUIN	21X111,5X4

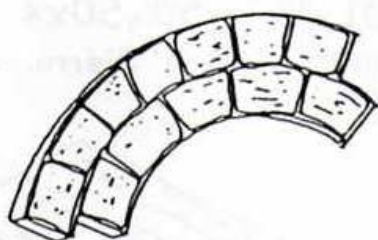

REFERENCIA	DESCRIPCIÓN	MEDIDAS CM
BL.12	E75-ADOQUIN ALCORQUE	R45X65X4

---

OTRAS MEDIDAS A CONSULTAR Tel(34)93 634 00 81

ASK FOR DIFFERENTS SIZES

CONSULTER AUTRES MESURES

**BALDOSAS ELASTOMERO**  
**ELASTOMER TILE PAVING**  
**DALLES ÉLASTOMÈRE**

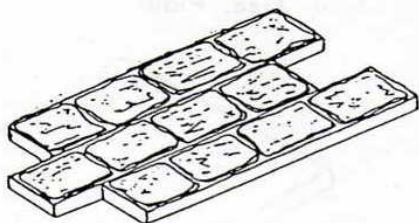

REFERENCIA	DESCRIPCIÓN	MEDIDAS CM
------------	-------------	------------

BL.13	E75-ADOQUIN CATALAN	42X71X4
-------	---------------------	---------

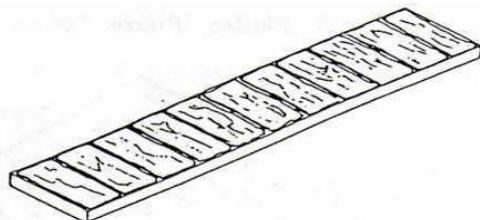

REFERENCIA	DESCRIPCIÓN	MEDIDAS CM
------------	-------------	------------

BL.14	E75-REMATE PIZARRA	20,5X98,5X3
-------	--------------------	-------------

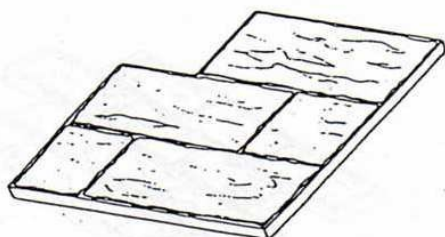

REFERENCIA	DESCRIPCIÓN	MEDIDAS CM
------------	-------------	------------

BL.15	E75-PIZARRA	48,5X60X4
-------	-------------	-----------

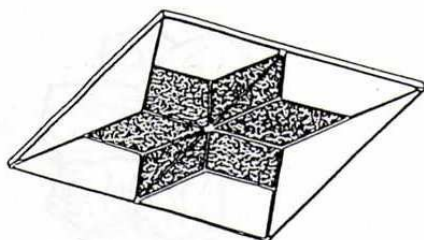

REFERENCIA	DESCRIPCIÓN	MEDIDAS CM
------------	-------------	------------

BL.16	E75-ESTEL	78,5X78,5X4
-------	-----------	-------------

OTRAS MEDIDAS A CONSULTAR Tel(34)93 634 00 81

ASK FOR DIFFERENTS SIZES

CONSULTER AUTRES MESURES

**MOLDES BALDOSA IMITACIÓN MADERA**  
**TILE PAVING MOULDS IMITATION WOOD**  
**MOULES DALLES IMITATION BOIS**

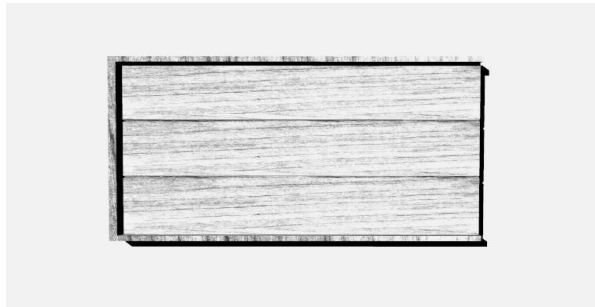

REFERENCIA	DESCRIPCIÓN	MEDIDAS CM
BL.21	E75 BALDOSA MADERA	70 X 40 X 3,5



REFERENCIA	DESCRIPCIÓN	MEDIDAS CM
BL.22	E75 BALDOSA MADERA	70 x 13 x 3,5

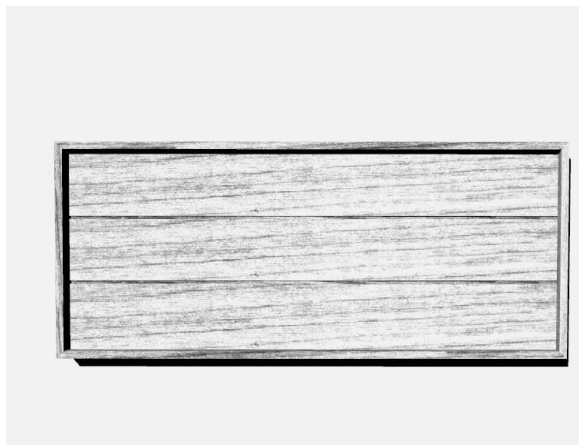

REFERENCIA	DESCRIPCIÓN	MEDIDAS
BL.23	E75-BALDOSA MADERA	100 X 40 X 3,5

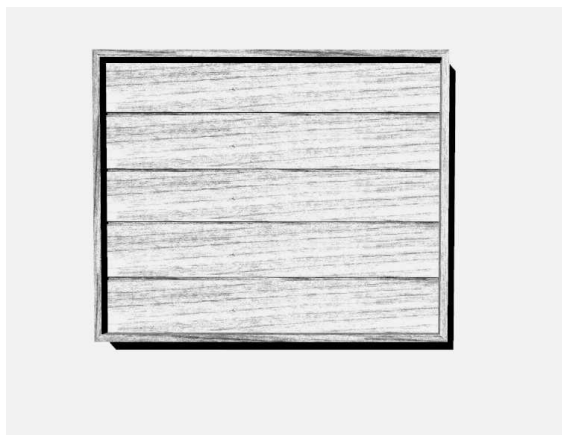

REFERENCIA	DESCRIPCIÓN	MEDIDAS CM
BL.30	E75-BALDOSA 5 TIRAS MADERA	70 X 57 X 3
BL.31	E75-BALDOSA 5 TIRAS MADERA	57 X 57

OTRAS MEDIDAS A CONSULTAR Tel(34)93 634 00 81

ASK FOR DIFFERENTS SIZES

CONSULTER AUTRES MESURES

**BORDILLOS POLIESTER**  
**POLYESTER EDGE-PIECE**  
**BORDURE POLYESTER**

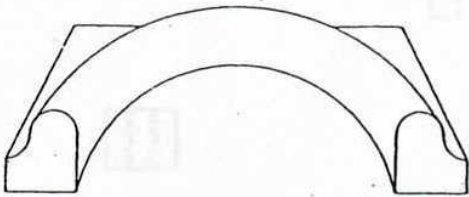

REFERENCIA	DESCRIPCIÓN	MEDIDAS CM
BDR.01.1	P-BORDILLO	120X60X17
BDR.01.2	P-BORDILLO	90X45X17

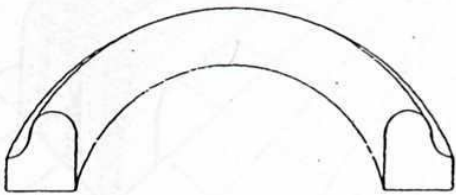

REFERENCIA	DESCRIPCIÓN	MEDIDAS CM
BDR.02.1	P-BORDILLO	90X60X17

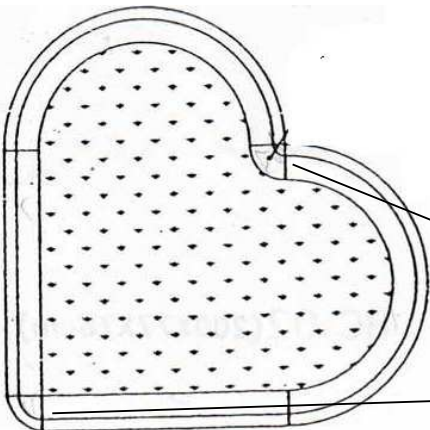

REFERENCIA	DESCRIPCIÓN	MEDIDAS CM
ES.BO.04.1	P-ESQUINA BORDILLO	15X15X17
ES.BO.04.1	P-ESQUINA BORDILLO	15X15X17

OTRAS MEDIDAS A CONSULTAR Tel(34)93 634 00 81

ASK FOR DIFFERENTS SIZES

CONSULTER AUTRES MESURES

**PELDAÑOS POLIESTER**  
**POLYESTER STEP**  
**DEGRÉ POLYESTER**

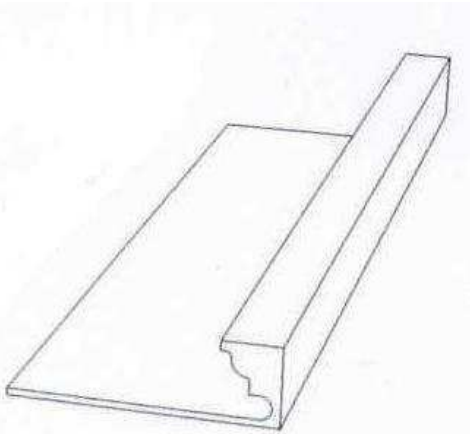

REFERENCIA	DESCRIPCIÓN	MEDIDAS CM
SFL.01	E75-PELDAÑO	200X35X14

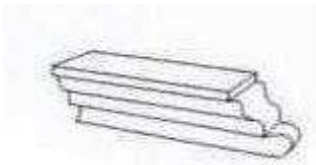

REFERENCIA	DESCRIPCIÓN	MEDIDAS CM
SFL11	E75-SEPARADOR MOLDURA IZQ.	46X13.5X13

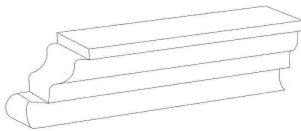

REFERENCIA	DESCRIPCIÓN	MEDIDAS CM
SFL.12	E75-EPARADOR MOLDURA DER.	46X13.5X13



REFERENCIA	DESCRIPCIÓN	MEDIDAS CM
SFL.13	E75-SEPARADOR	46X4X13

OTRAS MEDIDAS A CONSULTAR Tel(34)93 634 00 81

ASK FOR DIFFERENTS SIZES

CONSULTER AUTRES MESURES

**PELDAÑOS POLIESTER**  
**POLYESTER STEP**  
**DEGRÉ POLYESTER**

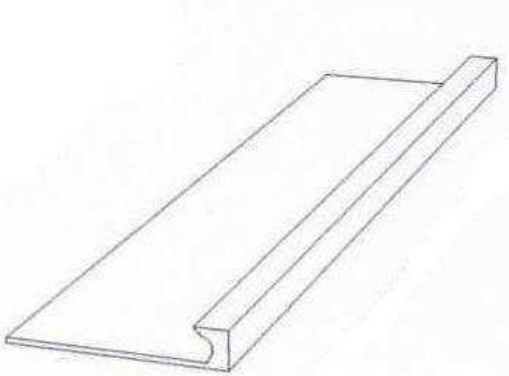

REFERENCIA	DESCRIPCIÓN	MEDIDAS CM
SFL.02	E75-PELDAÑO	195.5X34.4X6.7



REFERENCIA	DESCRIPCIÓN	MEDIDAS CM
SFL.21	E75-SEPARADOR MOLDURA IZQ.	39.5X8X6.5



REFERENCIA	DESCRIPCIÓN	MEDIDAS CM
SFL.22	E75-EPARADOR MOLDURA DER.	39.5X8X6.5



REFERENCIA	DESCRIPCIÓN	MEDIDAS CM
SFL.23	E75-SEPARADOR	39.5X4X6.5

OTRAS MEDIDAS A CONSULTAR Tel(34)93 634 00 81

ASK FOR DIFFERENTS SIZES

CONSULTER AUTRES MESURES

**COLUMNAS POLIESTER**  
**POLYESTER COLUMN**  
**COLONNE POLYESTER**

---

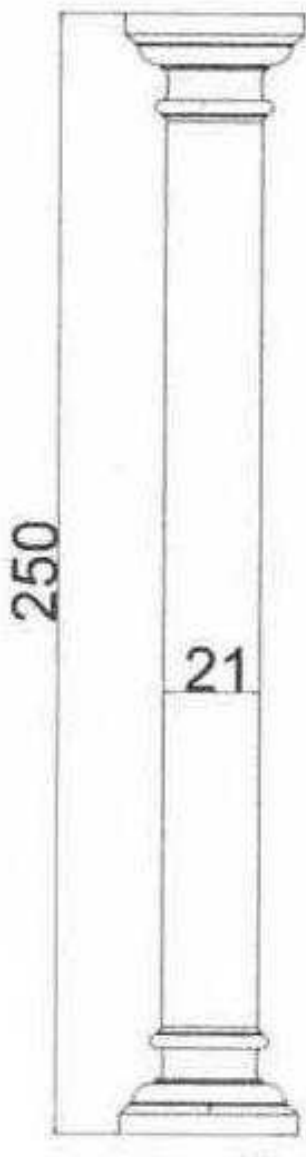

REFERENCIA	DESCRIPCIÓN	MEDIDAS CM
CL.01	P-COLUMNA GRIEGA	250X21

---

OTRAS MEDIDAS A CONSULTAR Tel(34)93 634 00 81

ASK FOR DIFFERENTS SIZES

CONSULTER AUTRES MESURES

**COLUMNAS POLIESTER**  
**POLYESTER COLUMN**  
**COLONNE POLYESTER**

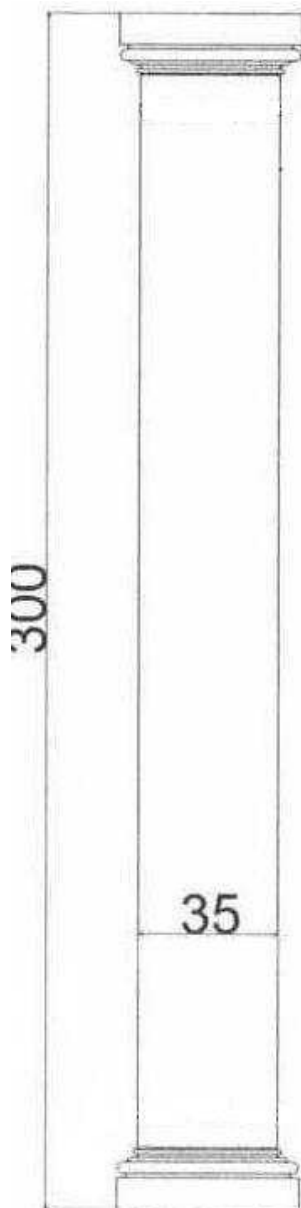

REFERENCIA	DESCRIPCIÓN	MEDIDAS CM
CL.01.01	P-COLUMNA GRIEGA	300X35

OTRAS MEDIDAS A CONSULTAR Tel(34)93 634 00 81

ASK FOR DIFFERENTS SIZES

CONSULTER AUTRES MESURES

**COLUMNAS POLIESTER**  
**POLYESTER COLUMN**  
**COLONNE POLYESTER**

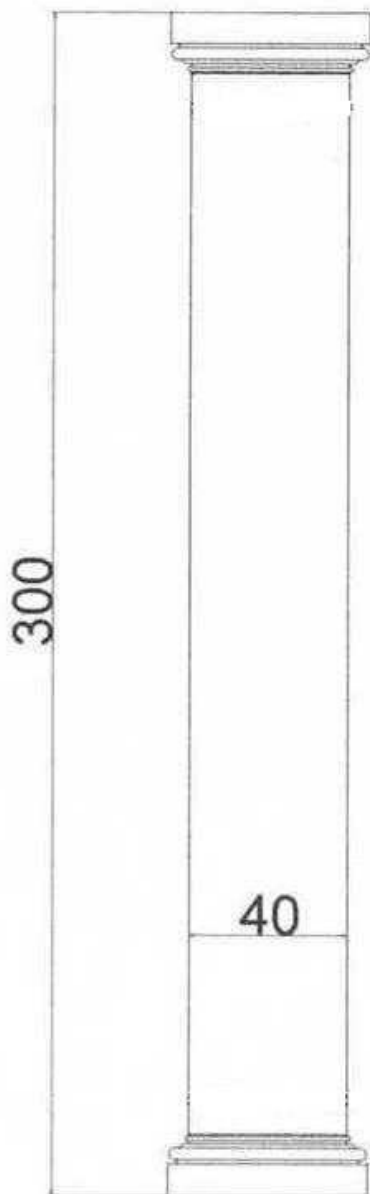

REFERENCIA	DESCRIPCIÓN	MEDIDAS CM
CL.01.02	P-COLUMNA GRIEGA	300X40

OTRAS MEDIDAS A CONSULTAR Tel(34)93 634 00 81

ASK FOR DIFFERENTS SIZES

CONSULTER AUTRES MESURES

**COLUMNAS POLIESTER**  
**POLYESTER COLUMN**  
**COLONNE POLYESTER**

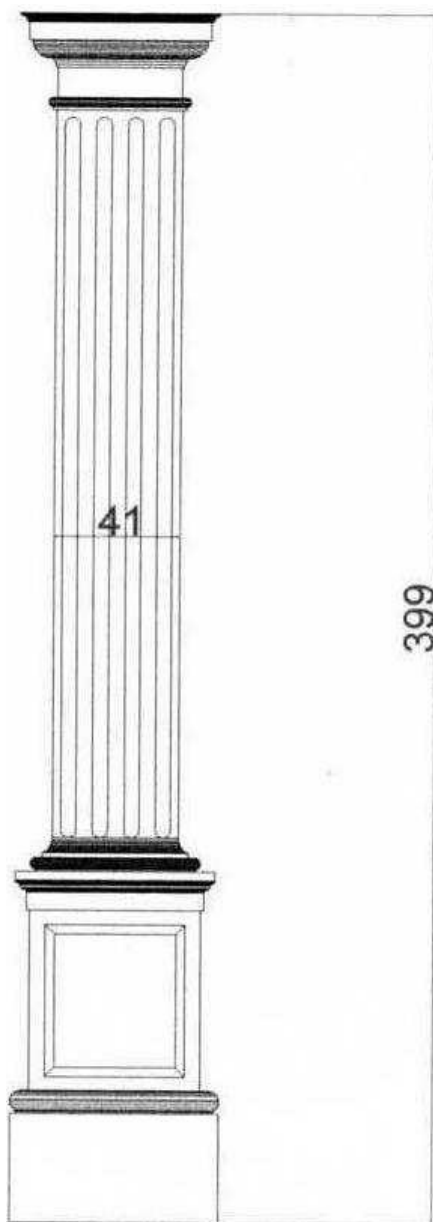

REFERENCIA	DESCRIPCIÓN	MEDIDAS CM
CL.02	P-COLUMNA ROMANA	399X41

OTRAS MEDIDAS A CONSULTAR Tel(34)93 634 00 81

ASK FOR DIFFERENTS SIZES

CONSULTER AUTRES MESURES

**COLUMNAS POLIESTER**  
**POLYESTER COLUMN**  
**COLONNE POLYESTER**

---

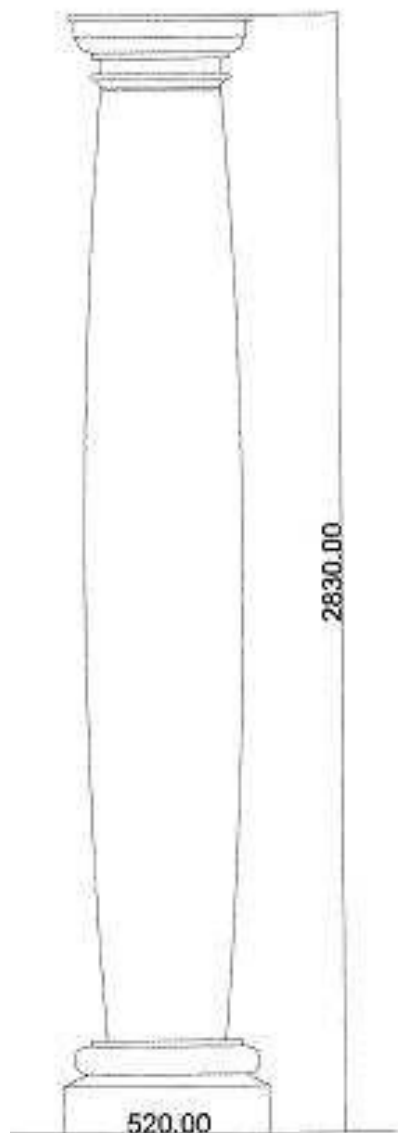

REFERENCIA	DESCRIPCIÓN	MEDIDAS CM
CL.03	P-COLUMNA TOSCANO	268X40

---

OTRAS MEDIDAS A CONSULTAR Tel(34)93 634 00 81

ASK FOR DIFFERENTS SIZES

CONSULTER AUTRES MESURES

**COLUMNAS POLIESTER**  
**POLYESTER COLUMN**  
**COLONNE POLYESTER**

---

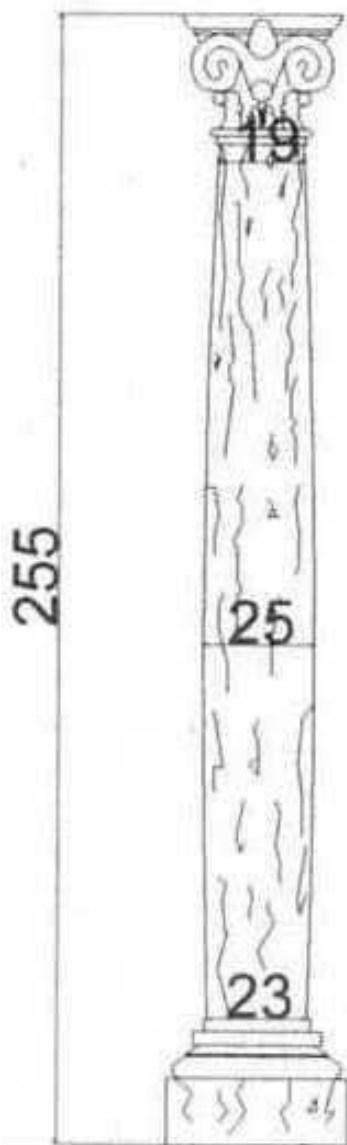

REFERENCIA	DESCRIPCIÓN	MEDIDAS CM
CLM.13	P-COLUMNA MADERA	255X25

---

OTRAS MEDIDAS A CONSULTAR Tel(34)93 634 00 81

ASK FOR DIFFERENTS SIZES

CONSULTER AUTRES MESURES

**COLUMNAS POLIESTER**  
**POLYESTER COLUMN**  
**COLONNE POLYESTER**

---

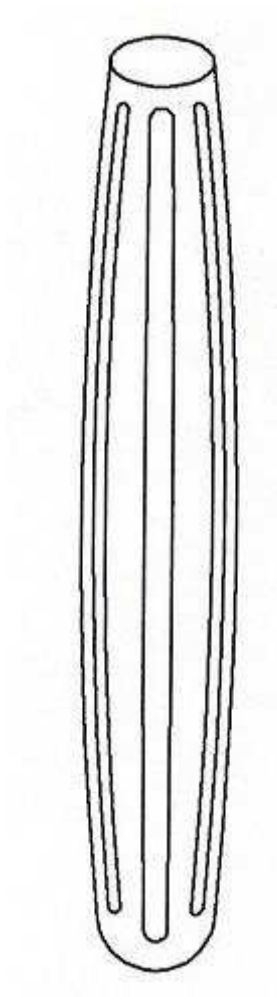

REFERENCIA	DESCRIPCIÓN	MEDIDAS CM
CL07	P-FUSTE OIIVAL	195X20/25

---

OTRAS MEDIDAS A CONSULTAR Tel(34)93 634 00 81

ASK FOR DIFFERENTS SIZES

CONSULTER AUTRES MESURES

**COLUMNAS POLIESTER**  
**POLYESTER COLUMN**  
**COLONNE POLYESTER**

---

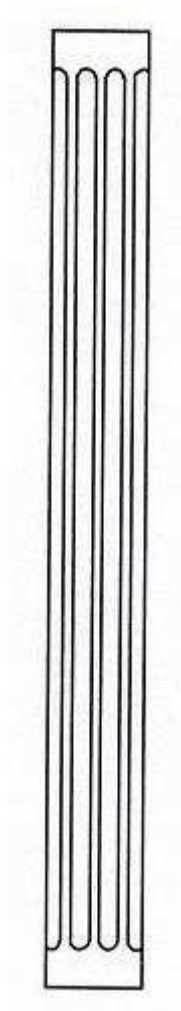

REFERENCIA	DESCRIPCIÓN	MEDIDAS CM
CL.08	P-FUSTE ESTRIADO	200X20

---

OTRAS MEDIDAS A CONSULTAR Tel(34)93 634 00 81

ASK FOR DIFFERENTS SIZES

CONSULTER AUTRES MESURES

**COLUMNAS POLIESTER**  
**POLYESTER COLUMN**  
**COLONNE POLYESTER**

---

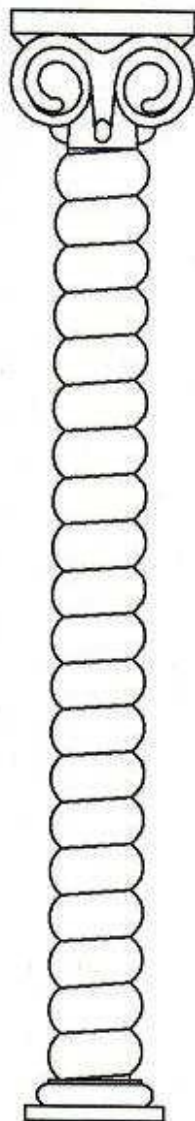

REFERENCIA	DESCRIPCIÓN	MEDIDAS CM
CL.06	P-COLUMNA SALOMONICA	240X20

---

OTRAS MEDIDAS A CONSULTAR Tel(34)93 634 00 81

ASK FOR DIFFERENTS SIZES

CONSULTER AUTRES MESURES

**COLUMNAS POLIESTER**  
**POLYESTER COLUMN**  
**COLONNE POLYESTER**

---

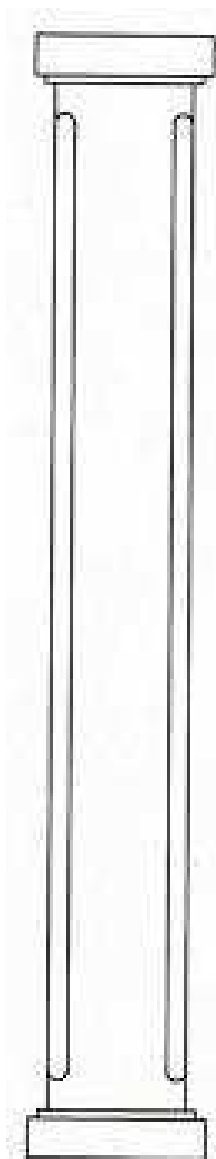

REFERENCIA	DESCRIPCIÓN	MEDIDAS CM
CL.04	P-COLUMNA CUADRADA	280X45X45

---

OTRAS MEDIDAS A CONSULTAR Tel(34)93 634 00 81

ASK FOR DIFFERENTS SIZES

CONSULTER AUTRES MESURES

COLUMNAS POLIESTER  
POLYESTER COLUMN  
COLONNE POLYESTER

---

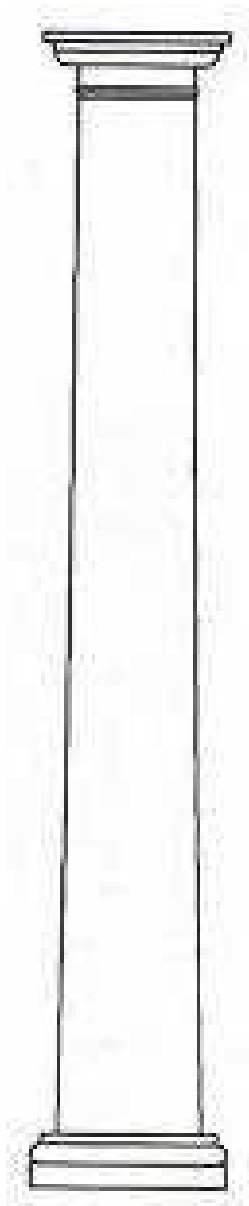

REFERENCIA	DESCRIPCIÓN	MEDIDAS CM
CL.05	P-COLUMNA DORICA	250X42

---

OTRAS MEDIDAS A CONSULTAR Tel(34)93 634 00 81

50

ASK FOR DIFFERENTS SIZES

CONSULTER AUTRES MESURES